

D

C

B

A

D

C

B

A

6

5

4

3

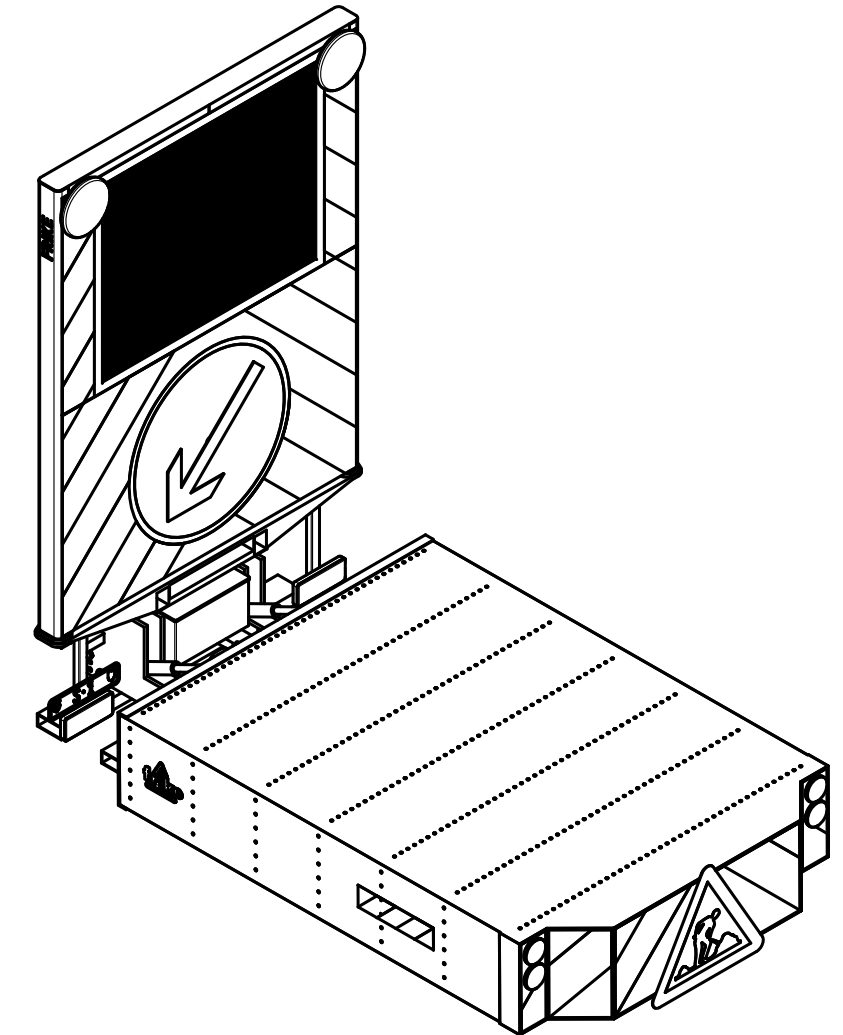
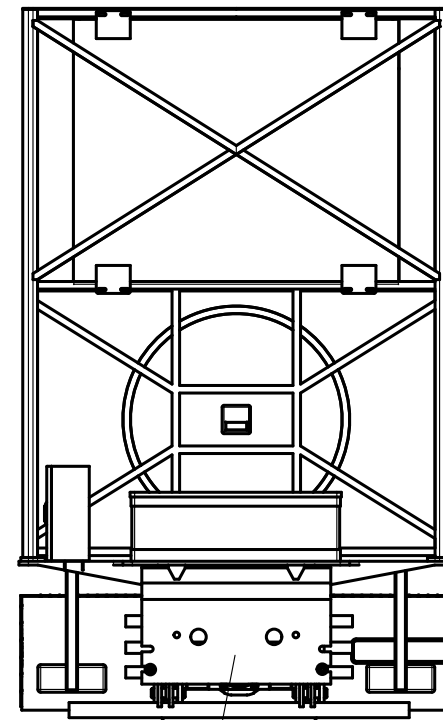
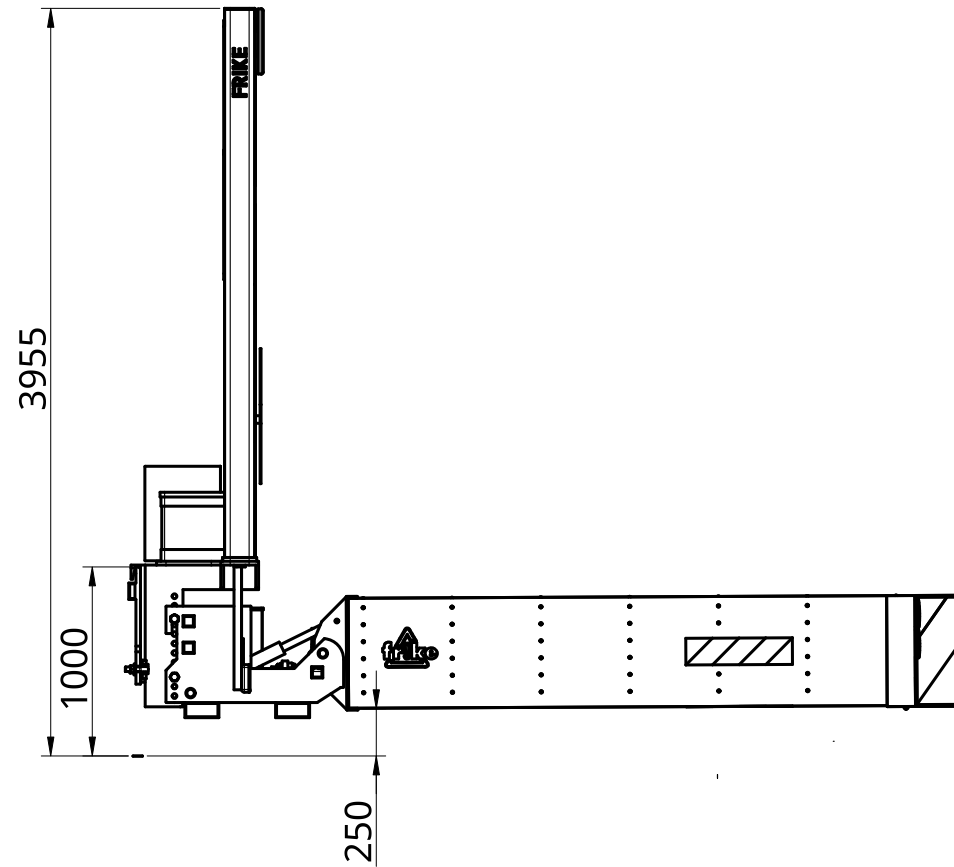
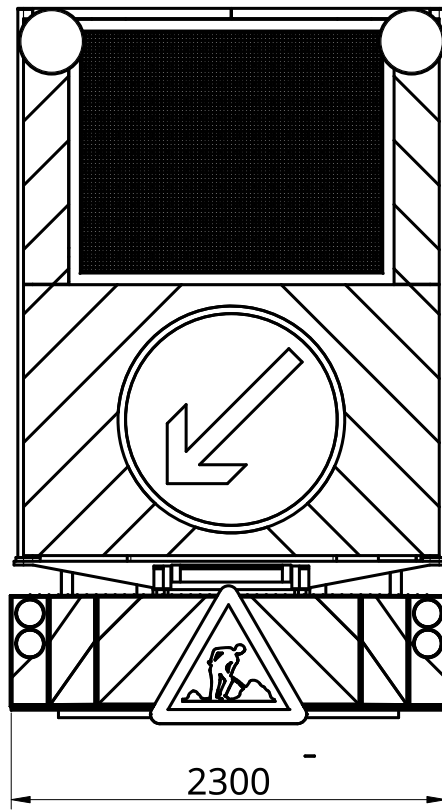

2

1

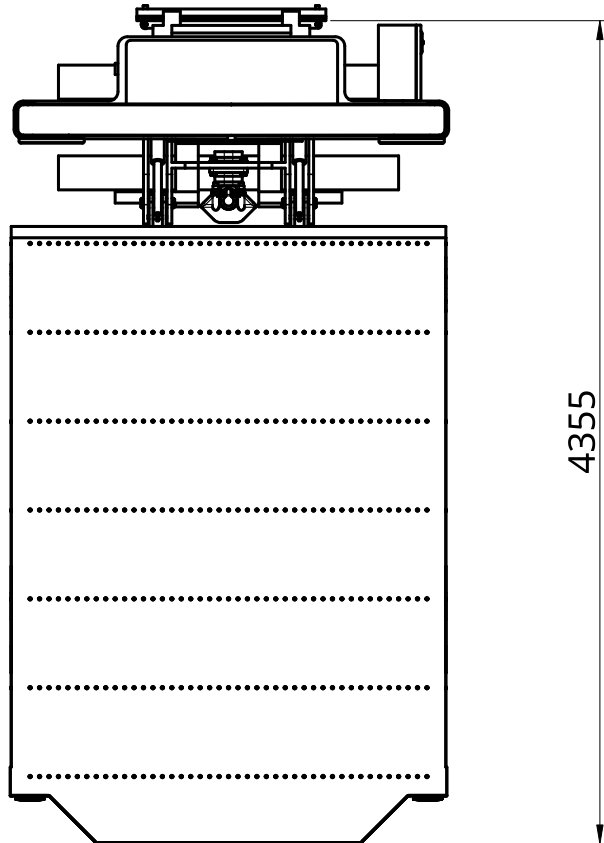

VSS-A Platte fahrzeugseitig
Oberkante 1m ab Boden.

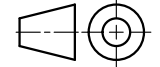

UNLESS OTHERWISE SPECIFIED, DIMENSIONS ARE IN MILLIMETERS NON-DIMENSIONED GEOMETRY ACCORDING TO DXF/STEP DATA GENERAL TOLERANCE STANDARD ISO 2768-mK APPLIES IF NOT STATED OTHERWISE DO NOT SCALE DRAWING BREAK ALL SHARP EDGES AND REMOVE BURRS FIRST ANGLE PROJECTION 		NAME	SIGNATURE	DATE	 Verkehrstechnik Technique du trafic Traffic Control Engineering	
	DRAWN	CAB		2024-05-15		TITLE
	CHECKED				FRIKE-TMA compact Übersicht offen V1.03 - Draft	
	APPROVED					
						DWG NO. REV.
	MATERIAL	FINISH		A3	SCALE	
					1:40 WEIGHT SHEET 1 of 1	

6

5

4

3

2

1